

Solar Pump System Instruction Manual

Introduction

Thank you for purchasing our solar pump system. To gain the maximum level of satisfaction from your pumping system, please carefully read the contents of this Instruction Manual and ensure that you install and use the system correctly and safely.

The solar pump system comprises four parts: solar array, solar pump, controller and water level sensor. It can be used as a highly effective water supply system in areas with a shortage of electricity for irrigation, fountains, ponds and water transferring.

Controller

The solar pump controller has the MPPT function (maximum power point tracking). It can transfer the input sunshine power into pump power and increase the efficiency of the whole solar pump system.

The controller has other functions including automatic control, over-current protection, under-voltage protection, whole-day running, unattended operation, and energy saving, economic.

The controller includes five parts: the connecting terminal, indicator lights, speed button, time-delay button and SOLAR-BAT diverter switch.

1. The connecting terminal operating instructions

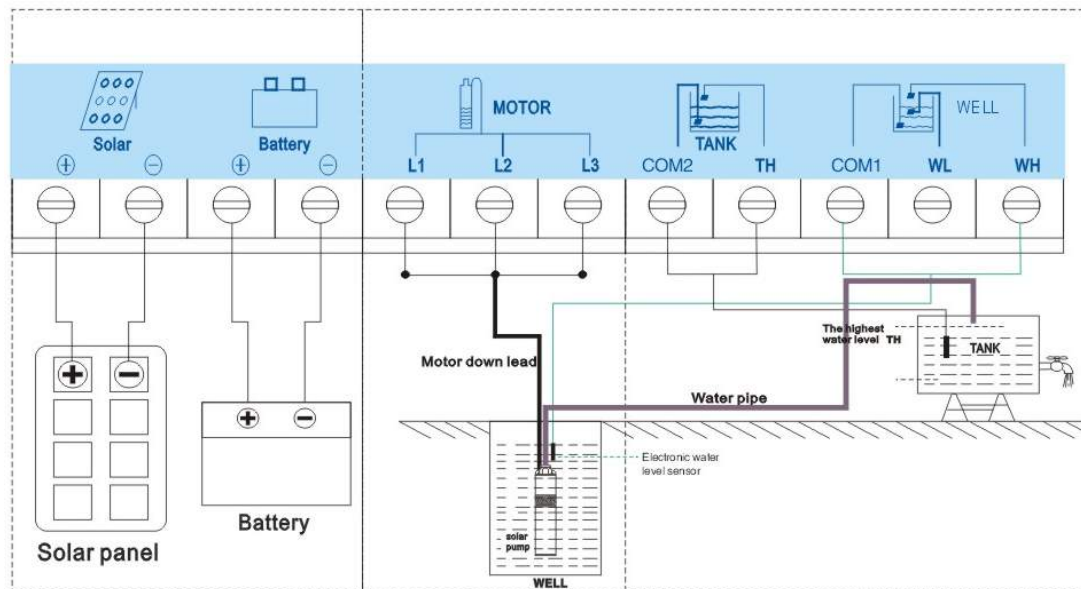

Terminal	Instruction
P+	Connect with the anode of solar array
P-	Connect with the cathode of solar array
B+	Connect with the anode of battery (for 12V,24V,36V,48V pumps only)
B-	Connect with the cathode of battery (for 12V,24V,36V,48V pumps only)
1	Connect with the cable "1" of pump (black cable)
2	Connect with the cable "2" of pump (blue cable)
3	Connect with the cable "3" of pump (brown cable)
COM2	Connect with the water level sensor of tank
TH	Connect with the water level sensor of tank
COM1	Connect with the water level sensor of well
WH	Connect with the water level sensor of well

2. Indicator lights instruction



label	Definition	Instruction
SYS	System power	Solar mode: Green light, the indicator lights are always on_(not battery mode) Battery mode: Green light, the indicator lights are blinking
Pump	Pump running	Green light, the indicator lights will be on after the pump running
MPPT	Maximum power point tracking	Green light, monitor the power input from the solar arrays and adjust the voltage and current to gain the highest performance from the pump
ERR_I	Current error	Over load indication: red light, the light is always on Over current indication: red light, the light is blinking
LOW_POWER	Voltage error	Yellow light, the light is always on which means the system voltage is too low with low power
Tank_F	Tank water level alarm	Green light, the tank is full
WELL_L	Well water level alarm	Green light, the well is empty. If the light blinking, it is in time-delay condition

NOTE: A. It means it is in battery mode if the MPPT and PUMP indicator lights are blinking at the same time.

B. It means the battery is over charged if the LOW-POWER indicator light blinks on battery mode.

3. The speed button function instruction



If you turn the speed button counterclockwise all the way, the system efficiency will decrease to only 30% of original efficiency. When turn the speed button clockwise all the way, the system efficiency will be 100%.

This function is to save the solar array's power for other uses or to start battery mode when you only need the low head working

4. Time delay button function instruction

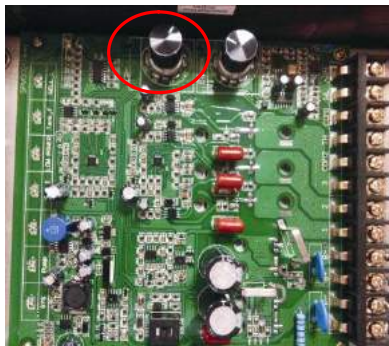

Turn the Time delay button to the constant number(the engraved lines at the top of button to the constant number). If the system checks that the well water level is lower than the water level sensor, the system will stop working and the WELL indication light will be on. When the well water level is higher than the water level sensor, the WELL indication light will start to blink until the delay time is over and WELL indication light is off and the system start to work.

The system would adjust the delay time according to the time-delay button, 0-30 minutes is available.

Note: A: When the system gets power for the first time, there is no time-delay function and will run directly.

B: If you do not need the time-delay function, turn the button to 0.

5. SOLAR-BAT diverter switch function instruction

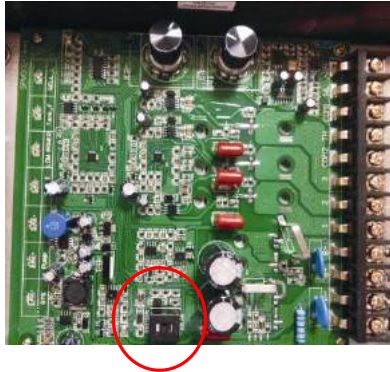

Here are three positions for the SOLAR-BAT diverter switch: solar array position, power-stop position(middle) and battery position. When using the solar array and battery, you only need to turn this switch to change the battery mode and solar mode.

Battery mode function instruction

(for 12V, 24V, 36V, 48V pumps only)

1. Five advantages for the battery mode:

A: The solar array can offer the power for battery charging and pump running at the same time

B: The solar array and battery can supply power for pump running at the same time

C: The solar array can supply the power for battery charging if there is insufficient sunshine and the pump stops running

D: Only the battery offers the power for pump running

E: When using the battery function, there is no need to reconnect the solar array and battery cables by manual, but only turn the SOLAR-BAT diverter switch to change the battery mode and solar mode

2. The indication lights for battery mode:



NO.	Indication lights	System stator
1	All the indication lights are blinking for one time	The system gets the power
2	“ SYS ” blinking	The system starts self-checking
3	“ SYS + PUMP + MPPT ”blinking	The system starts the charging mode

Note: A: Only when the pump stop running and the Speed button to the lowest speed, the battery charging indication lights start.

B: It means the battery is over charged if the LOW-POWER indication lights blinking.

3. The selection of battery(recommended)

Pump Power	Recommended Solar Panel			Solar Pump Controller (v)	Maintenance-free Valve Regulated Battery	
	VOC(V)	VMP(V)	Power(W)		Capacity(AH)/Voltage(V)/Quantity(PC)	Connection Mode
80W	21.5	17.5	110X1	12	120AH/12V/1PC	SERIES CONNECTION
120W	21.5	17.5	80X2	24	120AH/12V/2PCS	
210W	21.5	17.5	80X3	36	120AH/12V/3PCS	
500W	21.5	17.5	80X4X2	48	150AH/12V/4PCS	

The water level sensor instruction



The water level sensor includes the tank water level sensor and well water level sensor

1. Tank water level sensor:

The tank water level sensor is used to check the water level in the tank to avoid the water being too full and spilling out. Once the water level in the tank is higher than the sensor, the system will stop pumping water. Otherwise, the system will restart to pump water.

2. Well water level sensor:

The well water level sensor is used to detect the water level in the well to avoid the pump dry-running. Once the water level in the well is lower than the well water level sensor, the system will stop pumping water. Otherwise, the system will restart to pump water.

Note: A. the water level sensors cannot be connected if the well level is never drawdown. Please connect the COM1 and WH with a cable and make them short circuit.

B. The total water level sensors cable should less than 200M. If you would like to increase the cable length, please make sure the cable is connected completely and waterproof to avoid short circuit.

C. the water level sensors should be installed 10cm above the inlet of pump.

Solar Array Selection

Use the following graphics to help determine your optimal mounting angle. If you are located in the Northern hemisphere, face your panels south, and tilt back to an angle equal to your latitude. The opposite is required if located in the Southern Hemisphere. This is a standard year-round default position. For seasonal positioning, please see the chart below.

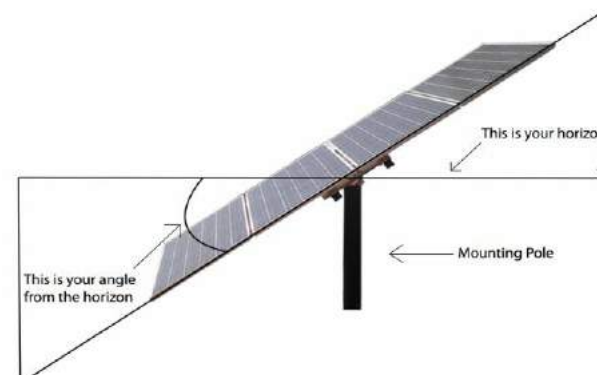

Latitude	Year Round Tilt	Summer Tilt	Winter Tilt
50°	60°	55°	65°
45°	55°	50°	60°
40°	45°	40°	50°
35°	40°	35°	45°
20°	20°	15°	25°

The selection of solar arrays for solar pumps(Recommended)

PUMP POWER (W)	SOLAR ARRAY (W)	SOLAR ARRAY QUANTITY	PEAK VOLTAGE VMP(V)	OPEN CIRCUIT VOLTAGE VOC(V)	ARRAY CONNECTION
80	110	110W*1	17-18	21-22	
120	160	80W*2	17-18	21-22	2 Pieces in series connection directly
210	240	80W*3	17-18	21-22	3 Pieces in series connection directly
500	640	80W*8	17-18	21-22	each 4 Pieces in series connection, 2 groups in parallel connection
600	800	100W*8	17-18	21-22	each 4 Pieces in series connection, 2 groups in parallel connection
750	1050	75W*14	17-18	21-22	each 7 Pieces in series connection, 2 groups in parallel connection
1000 (screw pump)	1400	100W*14	17-18	21-22	each 7 Pieces in series connection, 2 groups in parallel connection
1000 (plastic impeller & S/S impeller)	1600	100W*16	17-18	21-22	each 8 Pieces in series connection, 2 groups in parallel connection
1500	2300	230*10	30.5	36.8	each 5 Pieces in series connection, 2 groups in parallel connection
2200	3300	250*14	35	43	each 7 Pieces in series connection, 2 groups in parallel connection
3000	4500	250*18	35	43	each 9 Pieces in series connection, 2 groups in parallel connection

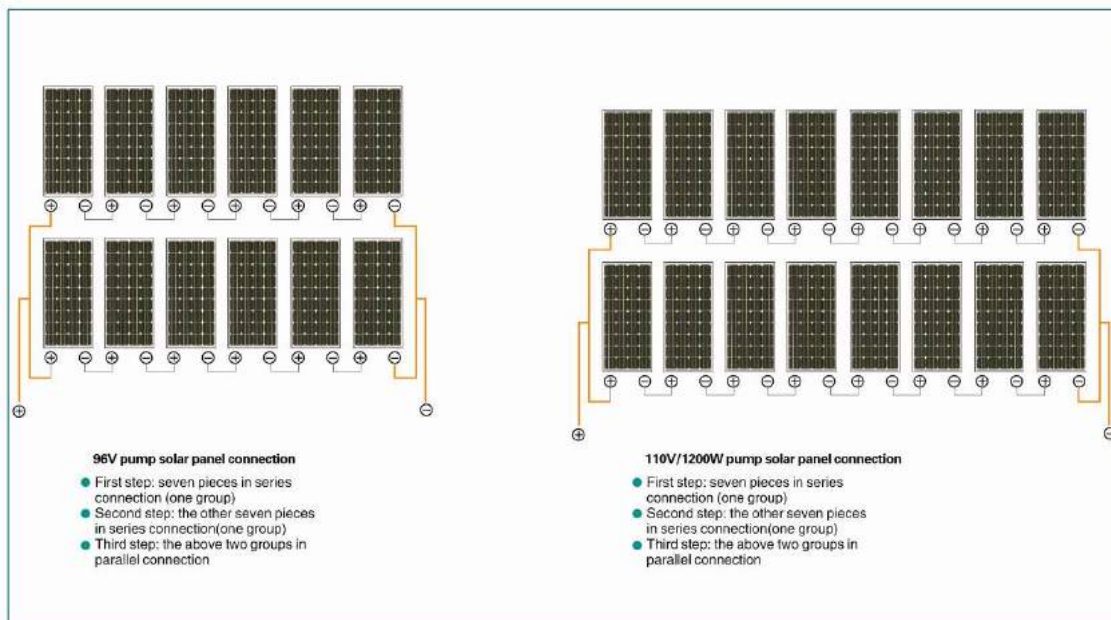
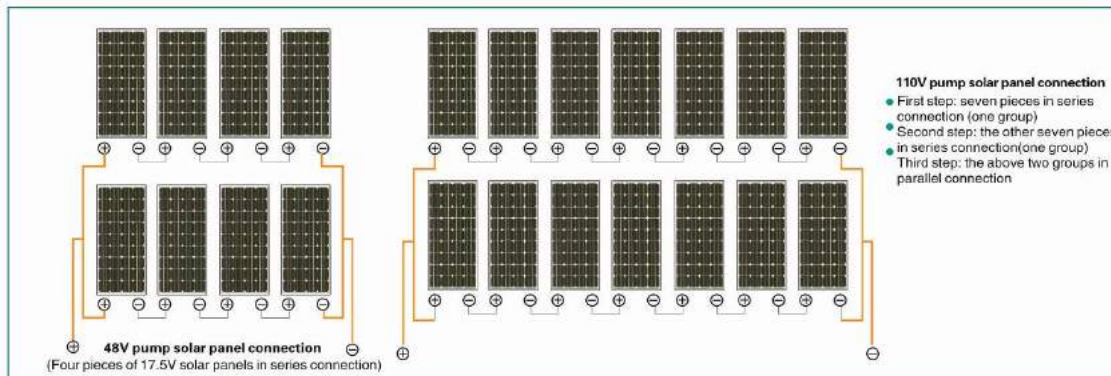
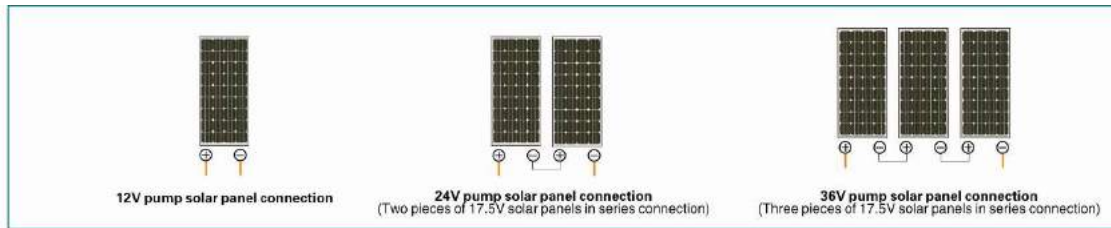

If use other types of solar arrays, please follow below instructions strictly

PUMP VOLTAGE (V)	SOLAR ARRAY (W)	PEAK VOLTAGE VMP(V)	OPEN CIRCUIT VOLTAGE VOC(V)
12V	≥1.3XPUMP POWER	≥15V	< 50
24V	≥1.3XPUMP POWER	≥30V	< 50
36V	≥1.3XPUMP POWER	≥45	< 100
48V	≥1.3XPUMP POWER	≥60	< 100
110V	≥1.5XPUMP POWER	≥112.	< 200
150V	≥1.5XPUMP POWER	≥150	< 250
220V	≥1.5XPUMP POWER	≥220	< 350
300V	≥1.5XPUMP POWER	≥300	< 450

Note: A. The performance information in the catalogue is the ex-works testing result for your reference only. The exact performance depends on circumstances like sunshine condition/solar array specification/ solar array efficiency. You should allow for a difference in the performance

B. Do please read and understand the solar array selection above carefully before connecting the solar arrays.

C. Open circuit voltage above limits will destroy the controller. This may occur if the solar array is wired incorrectly

Installation

The diagrammatic drawing for solar pump system installation and controller terminal board connection(For pump voltage ≤ 48V with battery mode)

Please remember to make the button to B when use the battery mode

Place the controller close to the solar array. This will reduce the risk of lightning damage

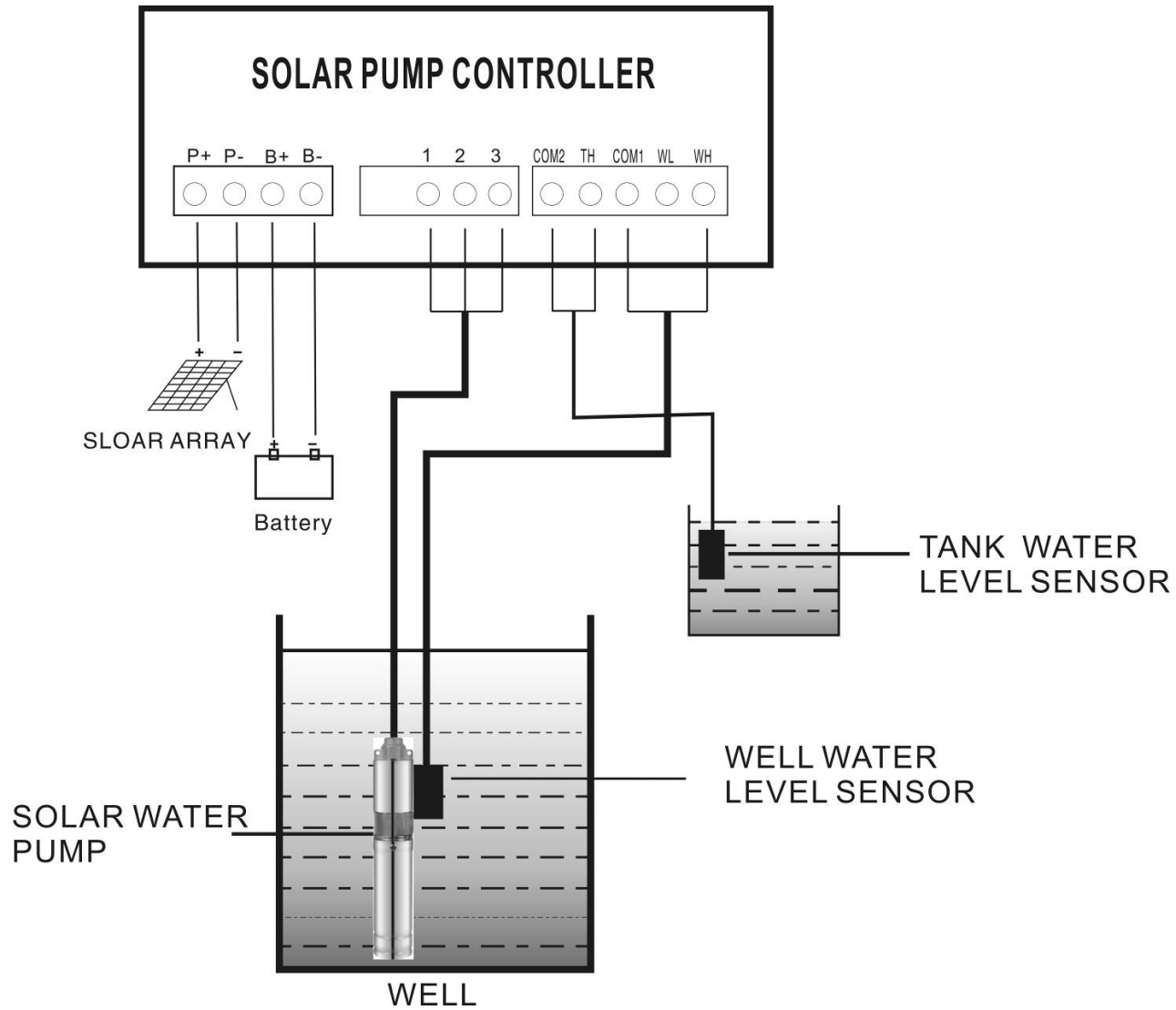

The diagrammatic drawing for solar pump system installation and controller terminal board connection (For pump voltage >48V without battery function)

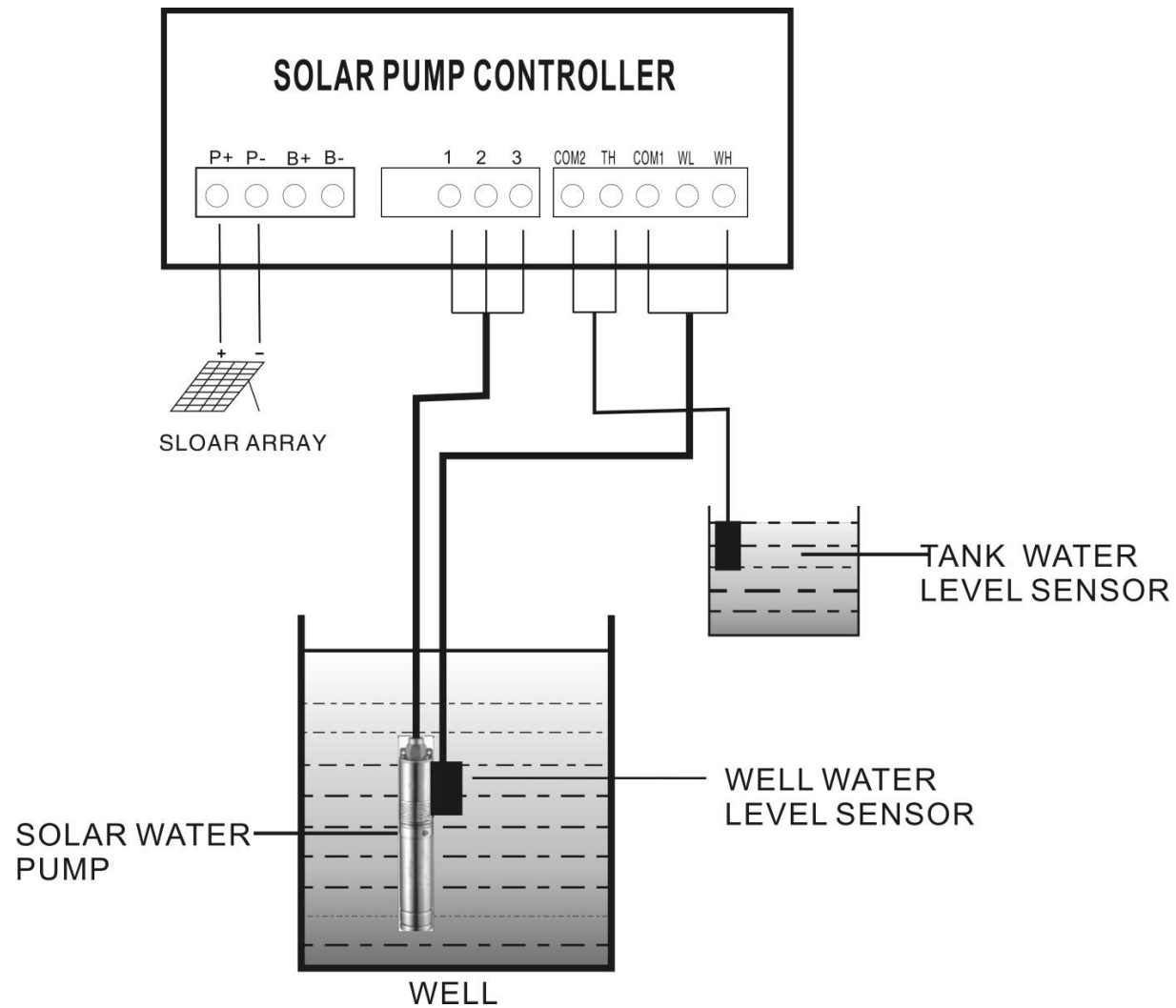

Splice the wires

Splice the pump wires using adhesive filled heat shrinkable tube. A standard heat gun or torch can be used. Start by heating the tubing in the middle and work your way to the edges. Adhesive should be oozing from each end of the shrinkable tube. This ensures that a good seal has been made.

- ① Connect the cable leads

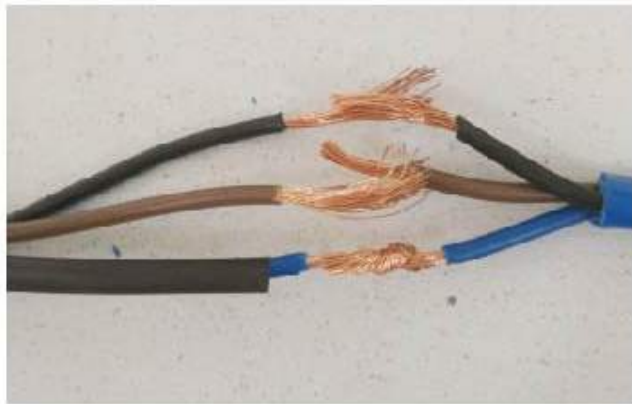

- ② Cover the joint with the small heat shrinkable tube



- ③ Tight the three cables with the water proof tape



④ Cover the whole cable with the big heat shrinkable tube



Serious Warning:

A. It is absolutely necessary that the solar array's open circuit voltage is NOT higher than the controller's rated open circuit voltage. The controller components will be damaged once the solar array's open circuit voltage is higher than the controller's rated open circuit voltage.

- B. In thunderstorm weather, please power off the cable between solar array and controller to avoid the thunderstrike damaging the controller to cause any loss.
- C. Keep the controller away from children's reach to avoid unnecessary harm.
- D. DO NOT open and close the controller chip by any person who does not have professional expertise to do so.
- E. The solar water pump system can only be used for clean water pumping like irrigation and living water and cannot be used for sand water and corrosive water.
- F. The surface water pumps should be kept away from the rain to avoid the motor being damaged by water.
- G. The maximum immersible depth of the submersible pump should be less than 30m
- H. These controllers are matched with our company's solar water pump and never allowed to be installed with any other products or for any other use. If you do so, we make no assurances as to the outcome and will not be liable for any consequences.

The notes for maintaining

- 1. Must cut off the controller power before any maintenance**
- 2. Must not put the metal spare parts into the controller to avoid the board short circuit.**
- 3. Must keep the controller clean when and after maintaining and no dust or water**